

Top View

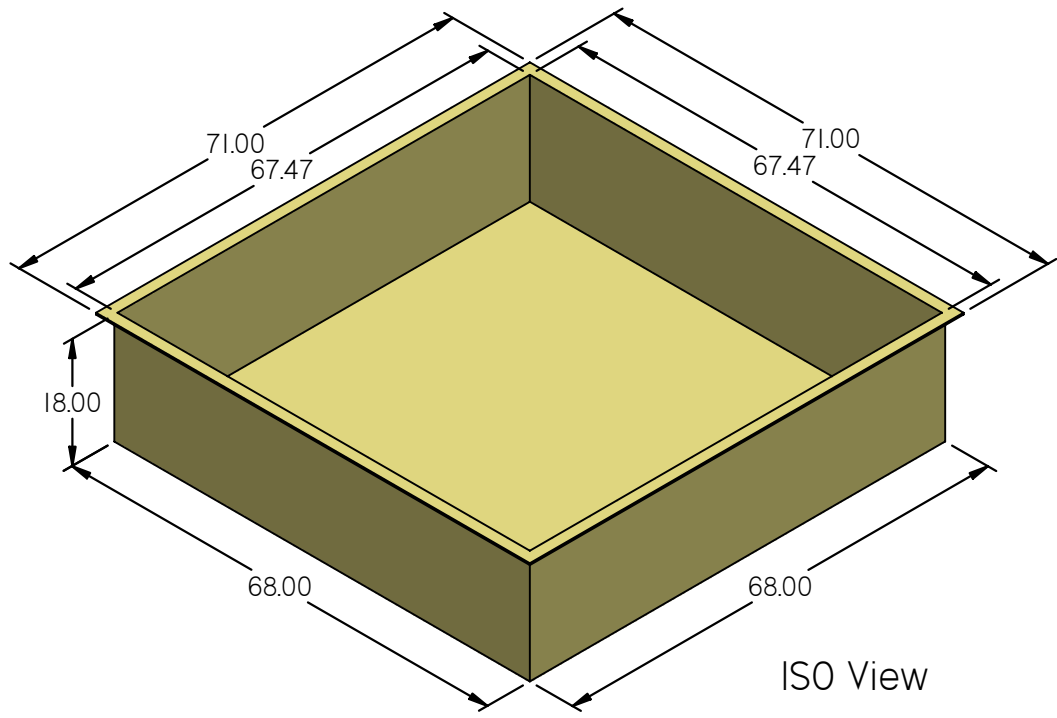

ISO View

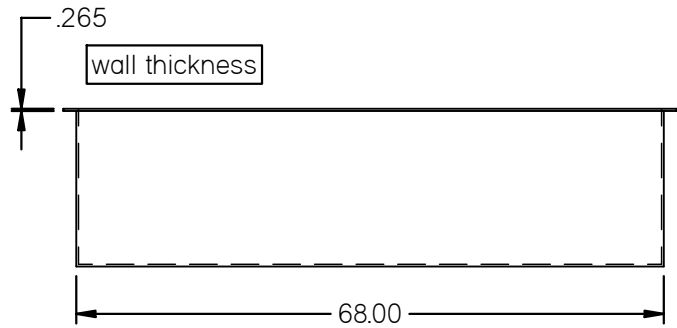

Front View

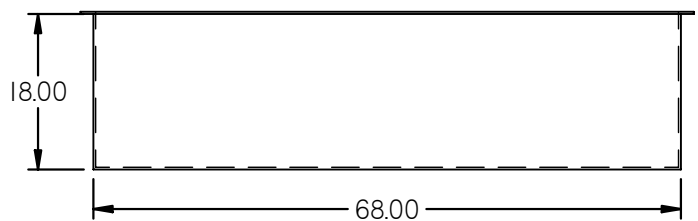

Side View

REVISION HISTORY			
REV	DESCRIPTION	DATE	APPROVED
01	MATERIAL CHANGE FROM LLDPE TO HDPE RESIN (200) NATURAL	1/2/2004	

NOTE: OPEN TANK WILL NEED SUPPORT IF FILLING UP BEYOND HALF WAY

Tank Capacity: 350 Gallons

	NAME	DATE
DRAWN	MPutt	2/17/2004
CHECKED		
ENG APPR		
MGR APPR		

UNLESS OTHERWISE SPECIFIED
DIMENSIONS ARE IN INCHES
ANGLES ±0.5°
2 PL ±0.125" 3 PL ±0.060"

TITLE 68" x 68" x 18" Open Top		
SIZE A	Material: HDPE Natural (200)	REV 01
FILE NAME: 501150 68x68.dft		
Part#: 501150	WEIGHT: 89.360 lbm	SHEET 1 OF 1