

REF. \_\_\_\_\_

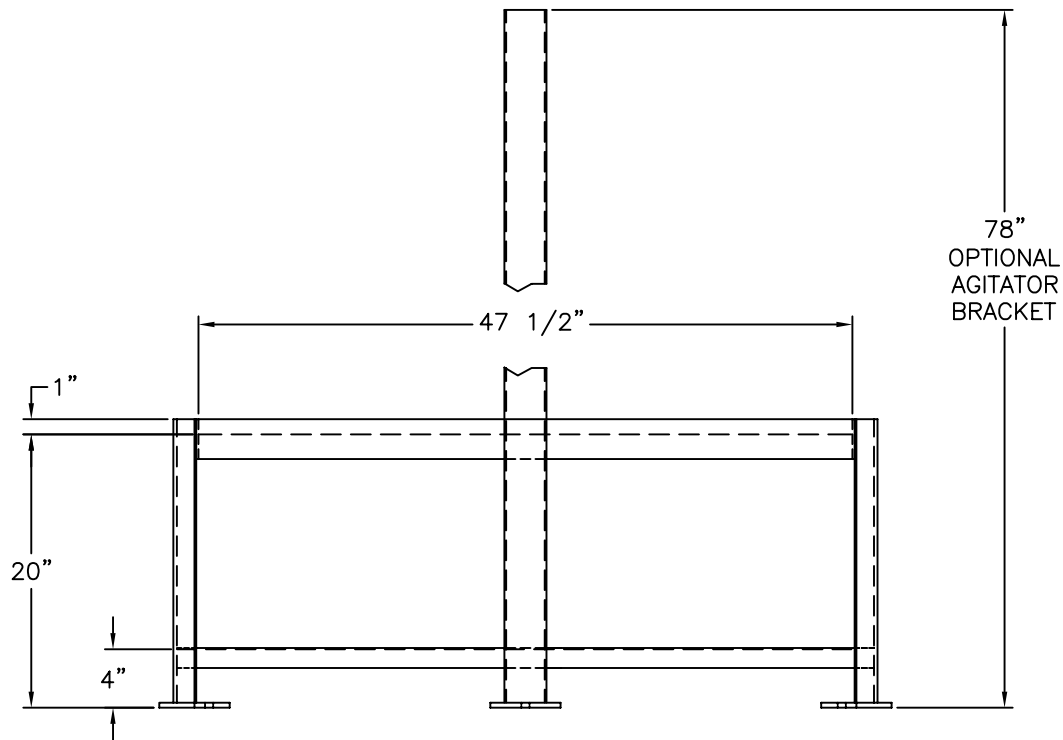
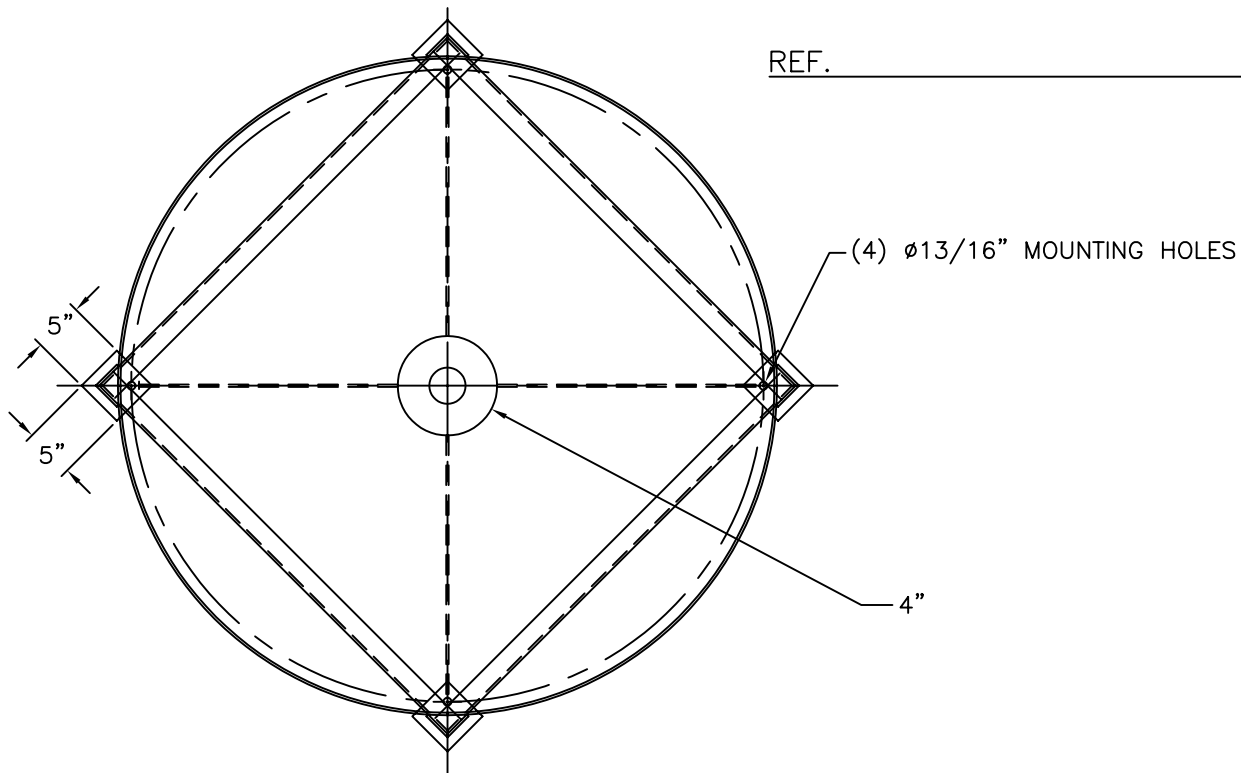

NOTE:  
ALL DIMENSIONS ARE APPROXIMATE  
NOT INTENDED FOR FABRICATION

Rev. 0	Date	File Name	
<b>CHEM-TAINER</b> Industries Inc. 361 Neptune Ave. N. Babylon, NY 11704 (631) 661-8300 Fax: (631) 661-8209		Date 02/22/05	Scale
TITLE 330 GALLON FLAT BOTTOM METAL STAND		Drawn By: K.Y.	Cust. Rep.
Part # TC-4548AK/AM		Dwg. #	